

AKM9710 STAINLESS STEEL MANUAL HOSE REEL



AKM9710

Max. working pressure	200 bar
Connection inlet - outlet	½" male – ½" male
Bore	12mm
Max. hose Ø	½"
Max. Hose length	¾" – 70m ½" – 50m
Weight	15 Kg
Material hose reel	AISI 304 / AISI 303
Material swivel	AISI 304 Seal: EPDM

DIMENSIONS AKM9710

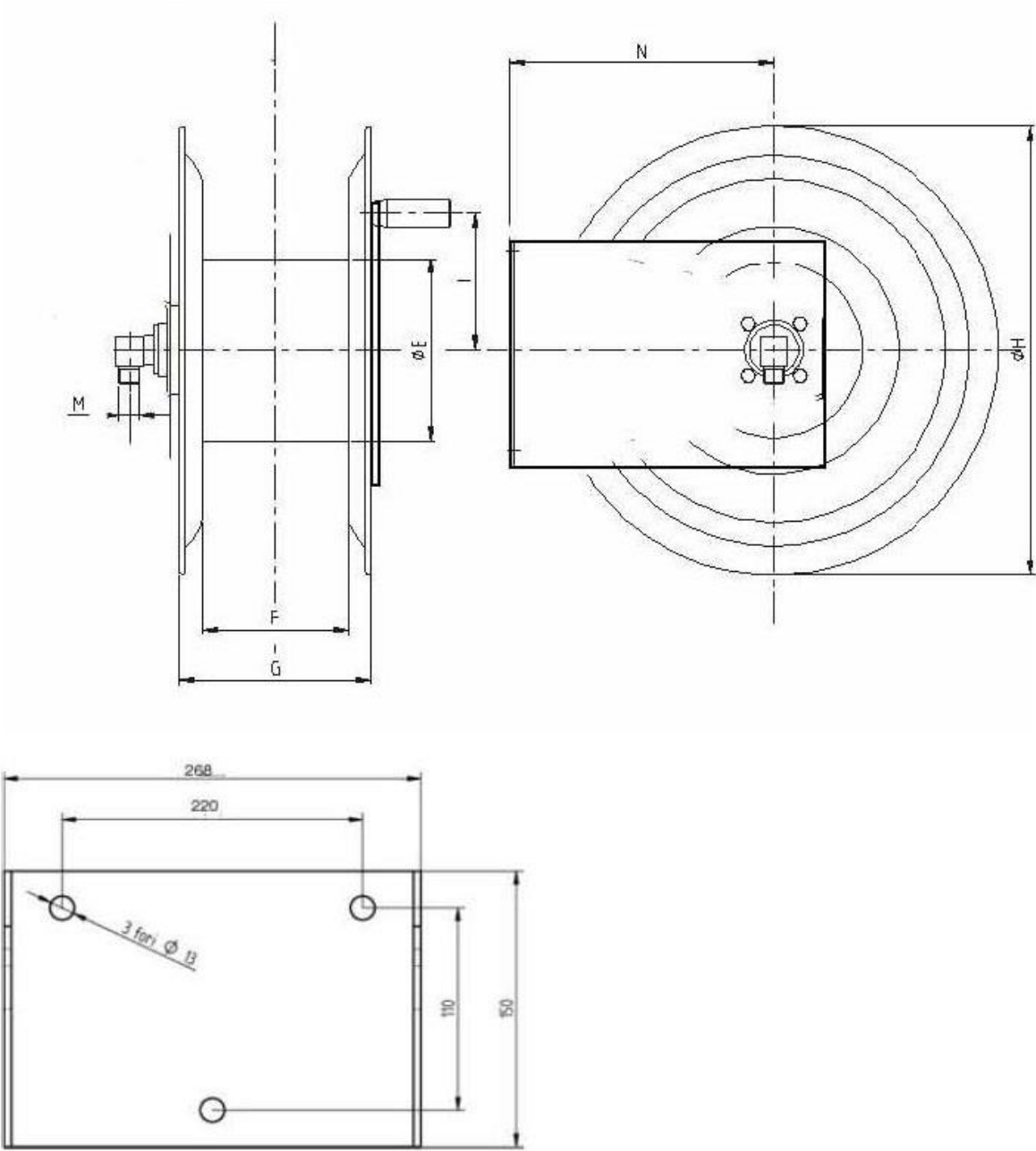

Art. Code	E	F	G	H	I	M	N
AKM9710	185	200	244	460	150	½"	260