

Manual hose reel type ATKi2 Mini



The ATKi2 Mini series is a manual hose reel for mounting on high-pressure cleaners. The reel consists of two profiled side discs and an open reel hub as well as a stable base frame.

Featured materials:

- Stainless steel 1.4301 (use in wet environment).

Drum bearing and brake:

The tried and tested, maintenance-free, chemical-resistant plastic plain bearings, insensitive to moisture and dirt, are used. A mechanical brake integrated in the bearing enables finely adjustable braking of the drum up to blocking.

Hose connection:

The hose connection is made through the drum at a 90° angle.

Additional locking by means of locking bolts:

On special request, all variants can be equipped with an additional locking device. A spring-loaded locking bolt allows the reel to be locked in 5 positions per reel revolution.

Angular swivel joint:

As standard, the angular swivel joints are always equipped with stainless steel axles. Depending on the nominal size, the housings are made of a hard-anodised die-cast aluminium alloy or chemically nickel-plated brass, or chemically nickel-plated brass. On request, all types can be supplied completely in stainless steel. The installed seals are made of PTFE and EPDM. However, they are also available in Viton at an extra charge.

Mounting options:

The hose reel can be mounted standing, hanging or on the wall. Special brackets are not required. The use of wall-mounted swivel brackets is not recommended for manual hose reels due to the physical conditions.

Areas of application:

Water, water with cleaning chemicals, air, oils and greases. The compact design of this reel makes it ideal for mounting on a mobile high-pressure cleaner. For example placed in a van or on a trailer. The maximum permissible operating temperature is 100°C as standard. If required, the reels can be modified up to 180°C at extra cost.

Accessories:

We will be happy to help you with further accessories or to assemble a suitable hose and gun for you.

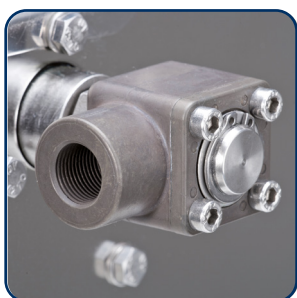

Angular swivel WDTH12/Al



Size ratio to ATKi2











Polyamide hand crank





Brake toggle available in blue or black

Technical Data

Hose reel ATKi2 Mini incl. Swivel WDT10/Al

Type	Article number	Recoilable hose length in M. outside- ϕ [mm]		Max. Pressure	Weight	Dimensions in mm			Materials	Price [€/St.]
										
					$\phi 15$	$\phi 20$	bar			kg
3/8" (DN10)										
	ATKi2Mini 20/10	20		300	5,0	210	3/8"	195	St. steel	Price on request
1/2" (DN12)										
	ATKi2Mini 20/12		15	200	5,0	210	1/2"	195	St. steel	Price on request

Additional accessories

Description	Article number	Price[€/St.]
		
Surcharge for 400bar version (only possible with 3/8" ATKi2 Mini) with 3/8" WDT10VA	MP1070003507	Price on request
Surcharge for gaskets for temp. 1-180°C and chemistry, 3/8" and 1/2" = DN10 and DN12	M1071001201	Price on request

Dimensions

Hose reel ATKi2 Mini

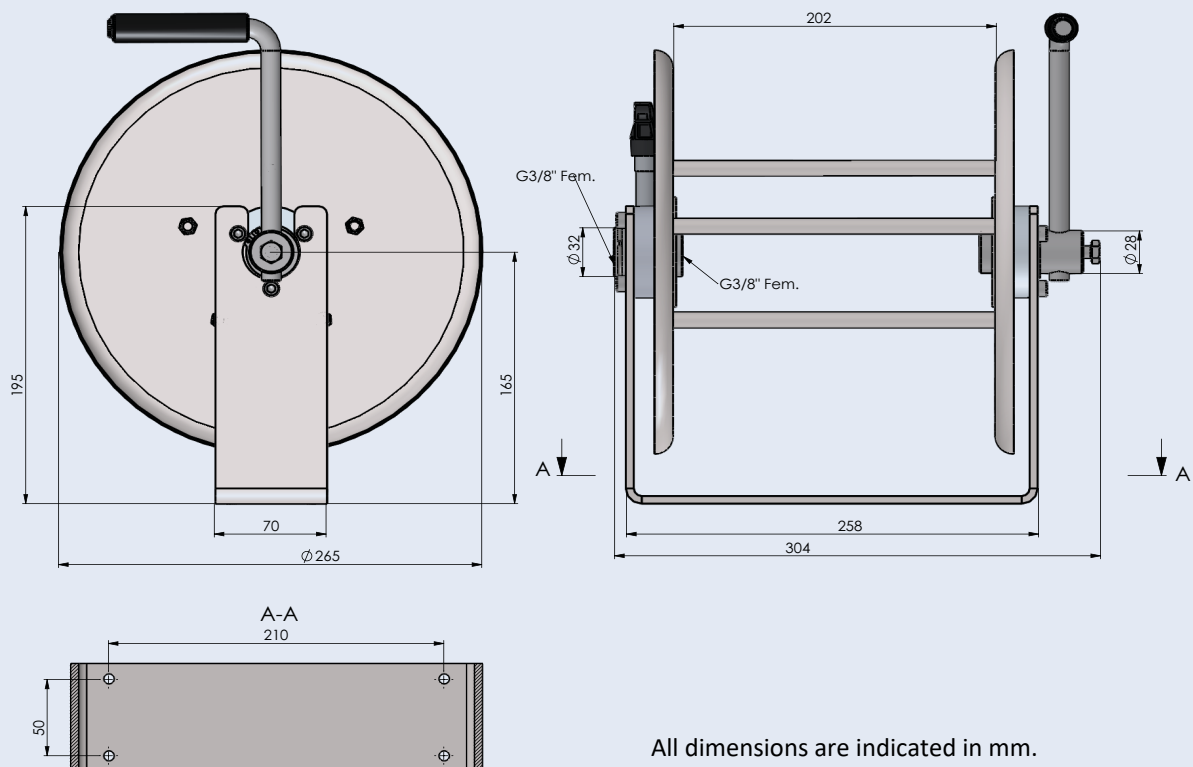

All dimensions are indicated in mm.
The hose connections are indicated in inches. AKBO