











Pièces de rechange







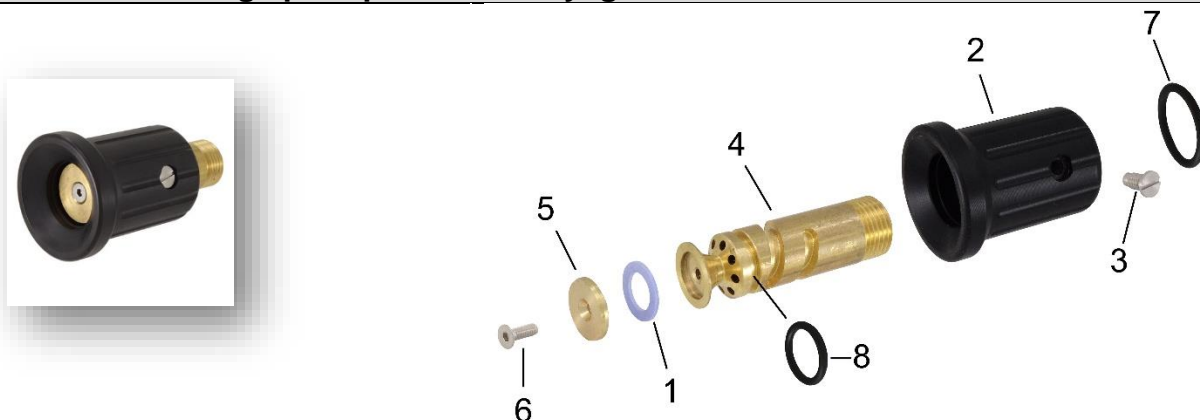

Pièces de rechange pour pistolet de nettoyage

No.	Image	N° d'article	Description
1		RESAKBO RESAKBL RESAKCH RESAKRV RESAKRB	Pour pistolet de nettoyage en laiton Pour pistolet de nettoyage en laiton avec grand débit Pour pistolet de nettoyage en laiton chromé Pour pistolet de nettoyage en INOX Pour pistolet de nettoyage en INOC avec grand débit
		RESAKNL2 RESAKCL2 RESAKRL2	Pour pistolet de nettoyage en laiton pour montage de lance Pour pistolet de nettoyage en laiton chromé pour montage de lance Pour pistolet de nettoyage en INOX pour montage de lance
		RESARBT RESRBTB	Kit de rechange pour AKRBT01-B-U Kit de rechange pour AKRBTB1-B-U
2		RECOVER-B RECOVER-W RECOVER-R RECOVER-G RECOVER-Y RECOVER-BL	Capot de caoutchouc EPDM, bleu Capot de caoutchouc EPDM, blanc Capot de caoutchouc EPDM, rouge Capot de caoutchouc EPDM, vert Capot de caoutchouc EPDM, jaune Capot de caoutchouc EPDM, noir
3		REGRIPP-B REGRIPP-W REGRIPP-R REGRIPP-RHP-R REGRIPP-G REGRIPP-Y REGRIPP-BL	Poignée en caoutchouc EPDM, bleu Poignée en caoutchouc EPDM, blanc Poignée en caoutchouc EPDM, rouge Poignée en caoutchouc EPDM pour AKRHP..., rouge Poignée en caoutchouc EPDM, vert Poignée en caoutchouc EPDM, jaune Poignée en caoutchouc EPDM, noir
4		RESCLIP	Clip pour pistolet
5		ADAM12M12F	Adaptateur en laiton 1/2" BSP mâle x 1/2" BSP femelle avec joint plat
		ADAR12M12F	Adaptateur en INOX 1/2" BSP mâle x 1/2" BSP femelle avec joint plat
6		RETRIPR-B RETRIPR-BL RETRIPR-R RETRIPR-W	Protection de levier, bleu Protection de levier, noir Protection de levier, rouge Protection de levier, blanc









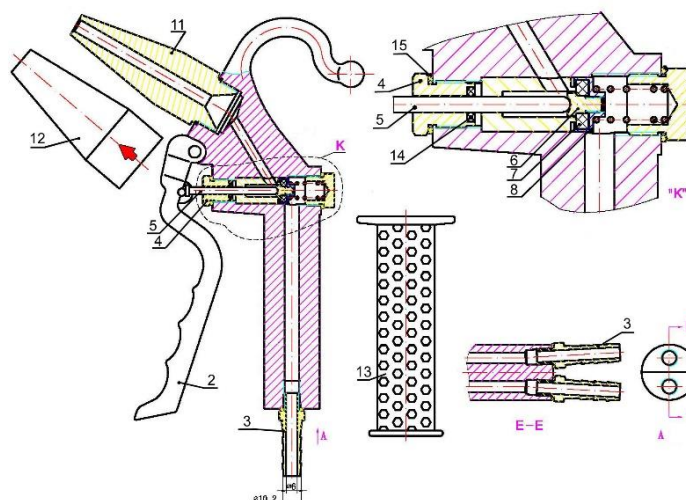

Pièces de rechange pour pistolet nettoyage industrielles

No.	Image	N° d'article	Description
1		AKSH4-FS	Joint plat "Clipperlon" 2110 (24x15x1,5)
2		AKSH4-HBL	Tête de POM, noir
		AKSH4-HW	Tête de POM, blanc
3		AKSH4-LS	Vis de blocage en inox, pour tête de POM
4		AKSH4-NS-M	Arbre de buse en laiton
		AKSH4-NS-R	Arbre de buse en INOX
5		AKSH4-NT-M	Pointe de buse en laiton
		AKSH4-NT-R	Pointe de buse en INOX
6		AKSH4-TS	Vis en inox, pour pointe de buse
7 8		AKSH4-OR	Joint EPDM



Pièces de rechange pour AKAWLU1-B pistolet air/eau









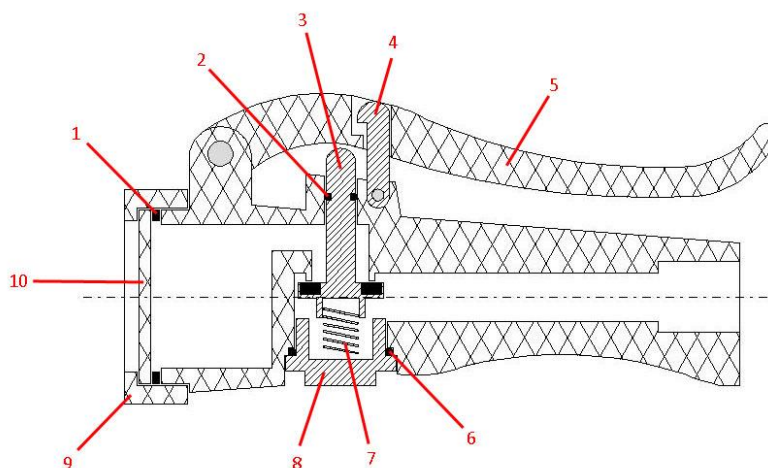

No.	Image	N° d'article	Description
2		AKAWTRIG	Poignée
3		AKAWTAIL	Embout de tuyau en laiton 3/8" x filetage mâle M9x1,25 incl. rondelle en laiton
6 7 8		AKAWPIST	Piston avec joints
4 5 14 15		AKAWSHAF	Arbre avec bouchon et joints
11		AKAWNOZZ	Buse en plastique
12		AKAWSLEE	Capot de caoutchouc EPDM pour buse
13		AKAWGRIP	Poignée en caoutchouc EPDM



Pièces de rechange pour douchette



No.	Image	N° d'article	Description
1 2 6		AKKSSEAL	Kit de joints: 1x O-ring 4,2 x 2 1x joint plat 26 x 40 x 2 1x O-ring 23 x 2
3		AKKSVALVE	Vannes
4		AKKSHOOK	Crochet en INOX
5		AKKSTRIG-B AKKSTRIG-W	Poignée, bleu Poignée, blanc
7		AKKSSPRING	Ressort en INOX
8		AKKSPLUG-B AKKSPLUG-C AKKSPLUG-R	Bouchon en plastique avec joint, bleu Bouchon en laiton chromé avec joint Bouchon en INOX avec joint
9		AKKSCAP-B AKKSCAP-W	L'écrou de buse, bleu L'écrou de buse, blanc
10		AKKSHEAD-B AKKSHEAD-W	Tête de pulvérisation, bleu Tête de pulvérisation, blanc

